



The Dayliff DE range of end suction centrifugal pumps are rugged heavy-duty pumps designed for various water supply, irrigation and fire fighting duties in agricultural, commercial and industrial applications. A wide range is available and pumps can be modified for specific duties by trimming the impeller diameter which must be done with reference to the particular pump curve. Motors should be selected according to the pump speed and impeller diameter and mounted together with the pumps on a base frame with coupling. The pumps are also suitable for belt drive by either electric motor or a diesel engine.

Features

- Heavy duty cast iron casing, bronze closed impeller and stainless steel shaft.
- Gland packing seal arrangement for ease of maintenance
- Back pullout design enabling removal of the rotating element without disturbing the pipework connections.
- Provided with connecting flanges and bolts.

Operating Conditions

Max Operating Pressure: 16Bar

Temp Range: -10°C to +105°C

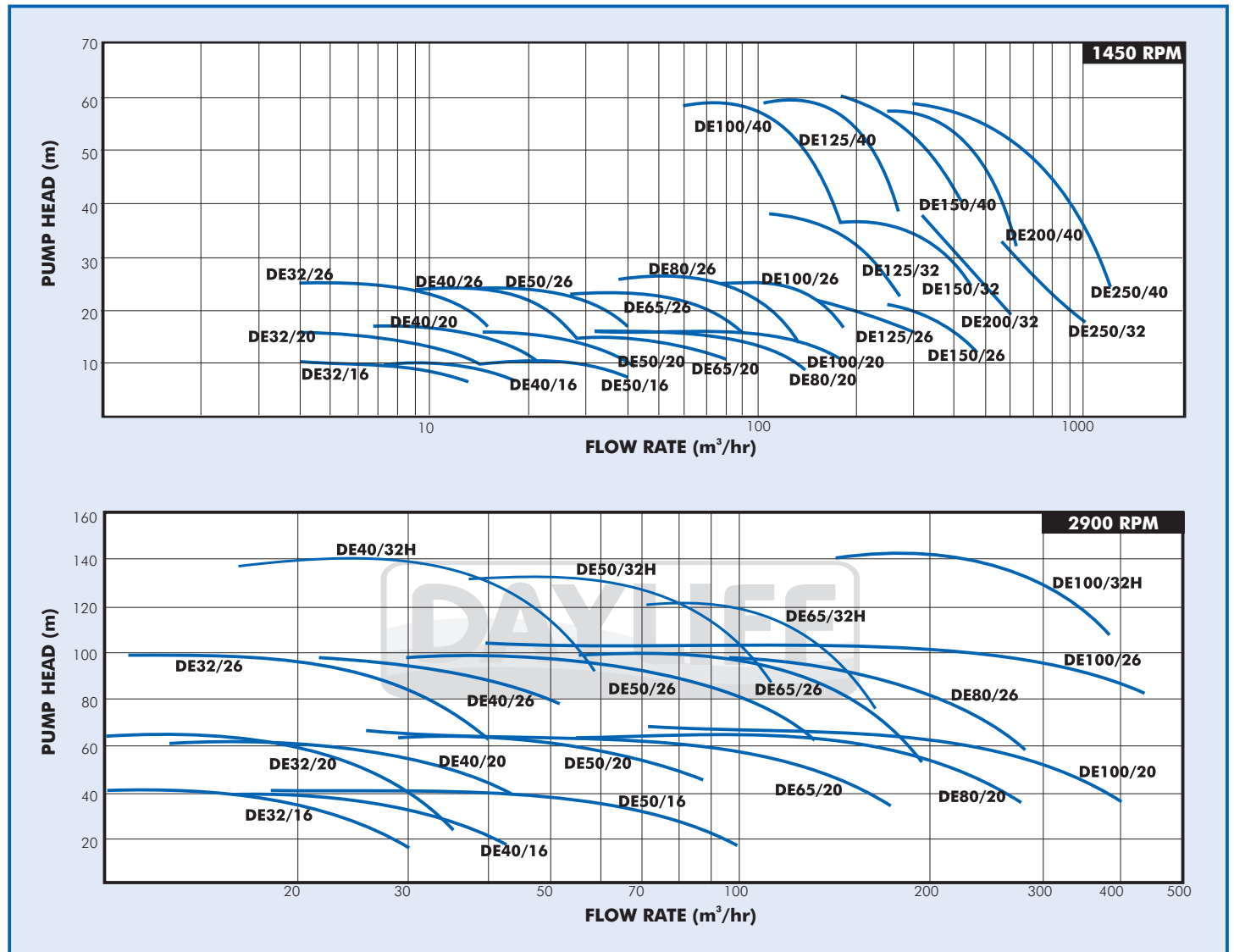

Pump Data

Model	Shaft Module	Discharge	Suction	Full Impeller Max. Power Absorbed		Dimensions (mm)					Weight (kgs)
				1450rpm	2900rpm	A	F	H1	H2	N1	
DE 32/16	25	32	50	0.5	4.5	80	360	132	160	240	35
DE 32/20	25	32	50	1	9	80	360	160	180	240	47
DE 32/26	25	32	50	2.2	19	100	360	180	225	320	58
DE 40/16	25	40	65	0.75	5.5	80	360	132	160	240	34
DE 40/20	25	40	65	1.2	9.2	100	360	160	180	265	45
DE 40/26	25	40	65	2.5	22	100	360	180	225	320	61
DE 40/32H	35	40	65	-	48	125	470	200	250	345	101
DE 50/16	25	50	65	1.5	11	100	360	160	180	265	39
DE 50/20	25	50	65	2.2	18	100	360	160	200	265	49
DE 50/26	25	50	65	4.5	40	100	360	180	225	320	68
DE 50/32H	35	50	65	-	70	125	470	225	280	345	105
DE 65/20	25	65	80	4	28	100	360	180	225	320	55
DE 65/26	35	65	80	5.5	55	100	470	200	250	360	87
DE 65/32H	35	65	80	-	85	125	470	225	280	400	111
DE 80/20	35	80	100	5.5	50	125	470	180	250	345	76
DE 80/26	35	80	100	10	75	125	470	200	280	400	95
DE 100/20	35	100	125	7.5	55	125	470	200	280	360	84
DE 100/26	35	100	125	15	130	140	470	225	280	400	102
DE 100/32H	35	125	100	-	175	140	470	250	315	400	134
DE 100/40	45	125	100	40	-	140	470	280	355	500	174
DE 125/26	35	150	125	24	-	140	530	250	355	400	115
DE 125/32	45	150	125	31	-	140	530	280	355	500	163
DE 125/40	45	150	125	60	-	140	530	315	400	500	181
DE 150/26	45	200	150	27	-	160	530	250	355	450	148
DE 150/32	45	200	150	50	-	160	530	280	400	550	170
DE 150/40	45	200	150	76	-	160	530	315	450	550	209
DE 200/32	55	250	200	60	-	180	670	315	480	600	251
DE 200/40	55	250	200	125	-	180	670	335	480	600	295
DE 250/32	55	300	250	83	-	220	691	335	520	660	311
DE 250/40	55	300	250	129	-	220	682	400	560	660	390

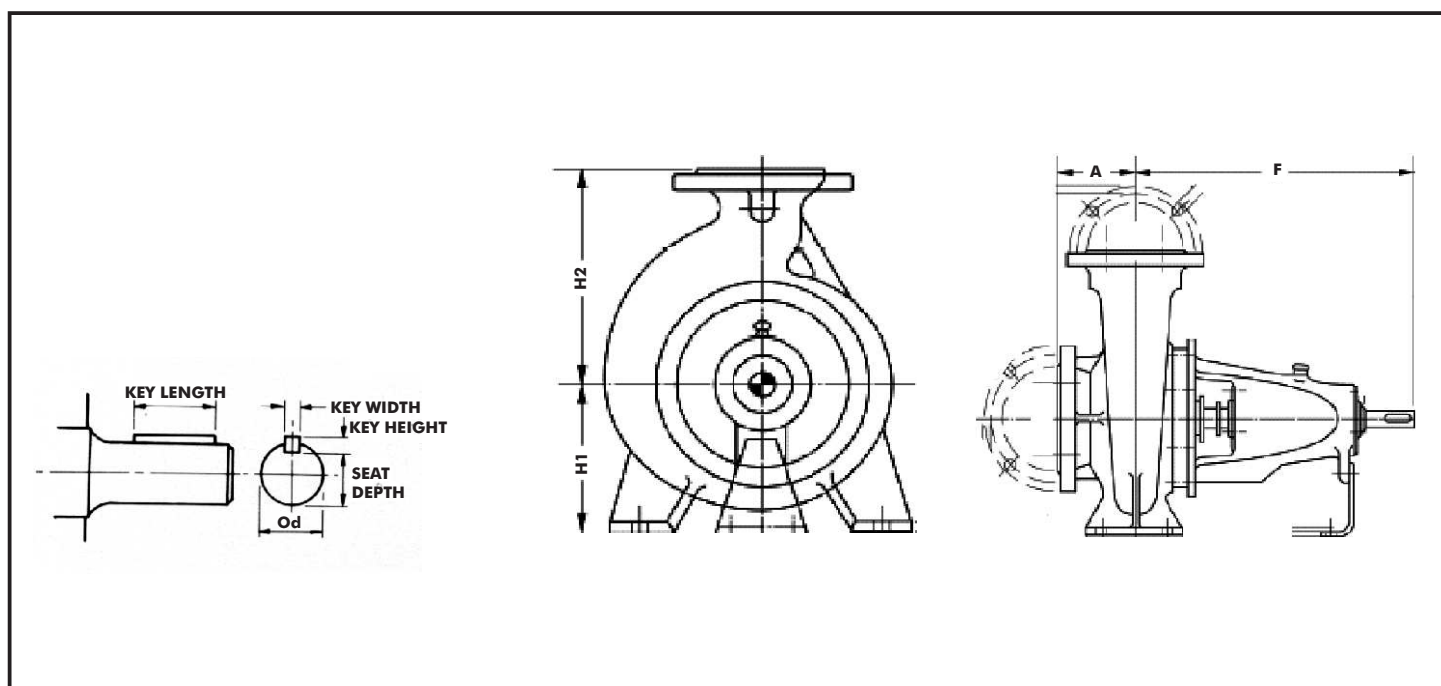

MODEL DE 100/20

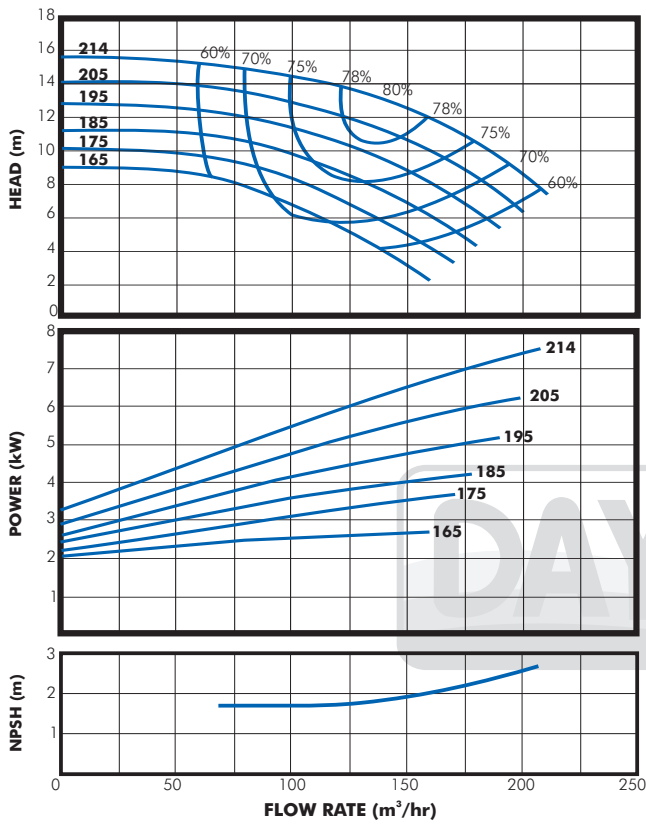

MODEL DE 100/26

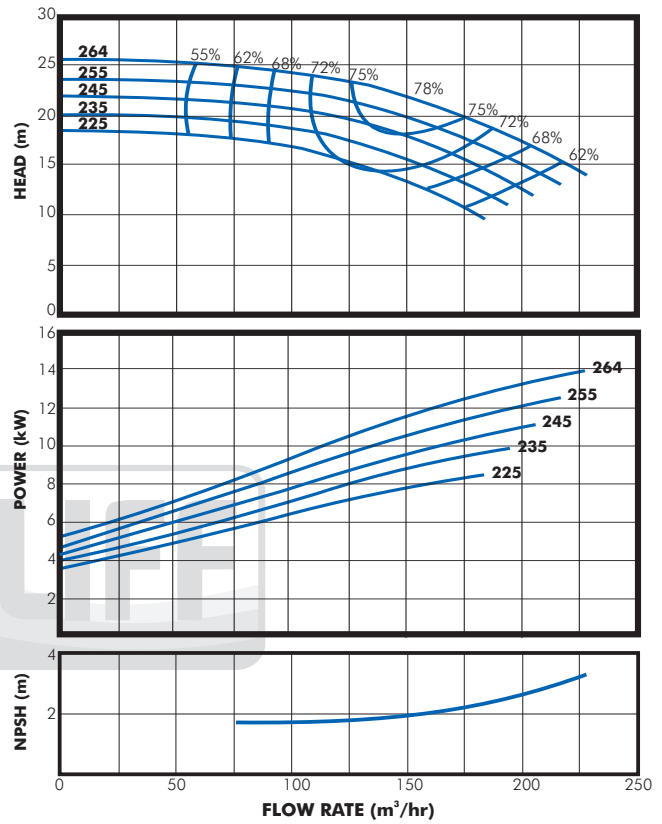

MODEL DE 100/40

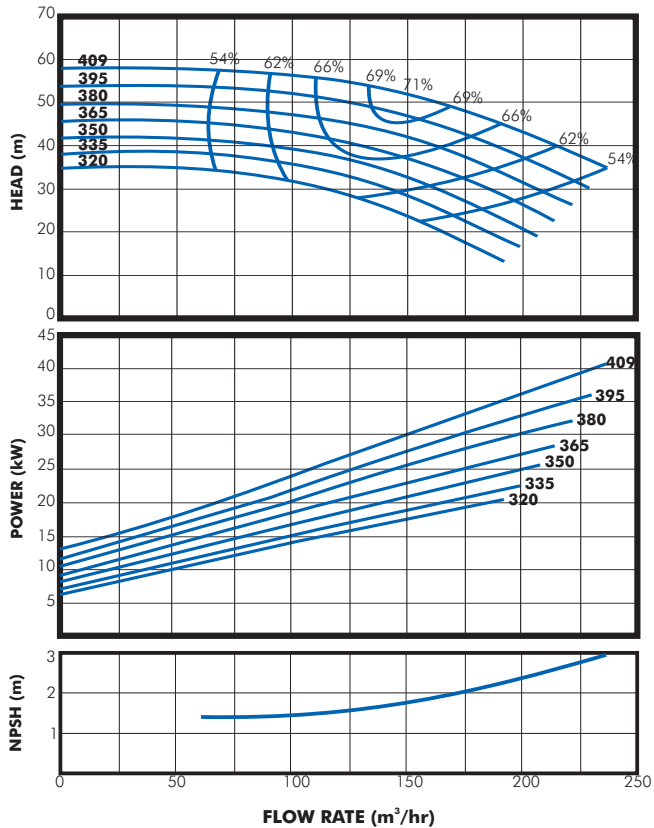

MODEL DE 100/20

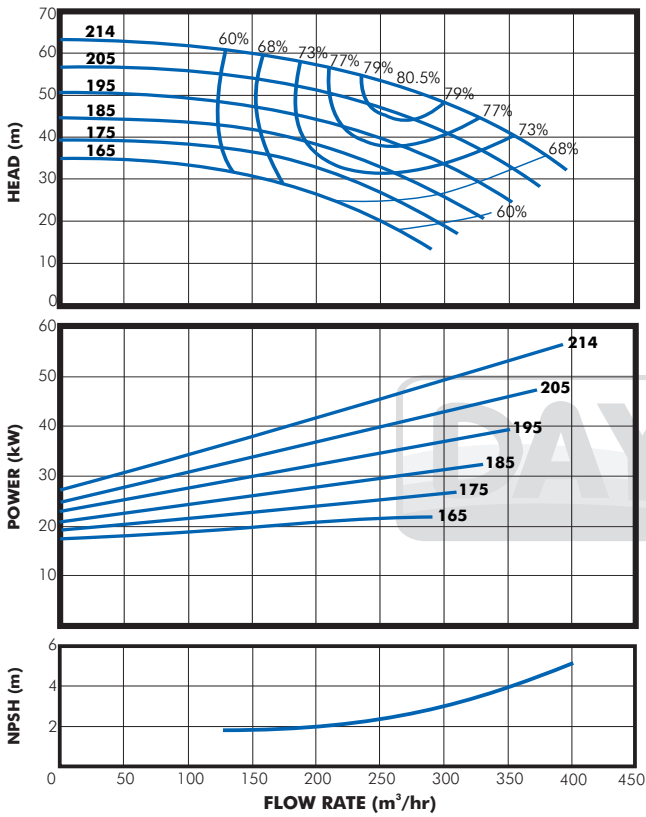

MODEL DE 100/26

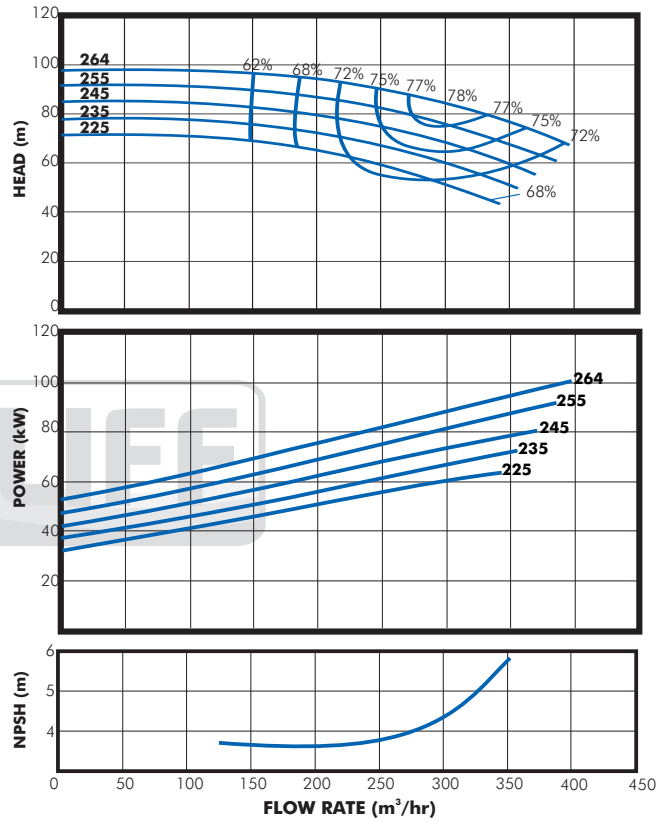

MODEL DE 100/32H

